

mesytec **MSCF-16-LN** is an **ultra low noise** spectroscopy amplifier with active baseline restorer. It provides timing filter amplifiers with constant fraction discriminators and a multiplicity trigger. It is completely revised to meet the requirement of high quality germanium detector readout.

Features:

- 16 channel NIM module, low power design
- Shaping amplifiers with active baseline restorer
- Timing filter amplifiers
- CF discriminators (opt.: leading edge)
- ECL timing output with digital delay of 800 ns
- Trigger output
- Multiplicity trigger
- Remote control of discriminator thresholds, shaping time, gains and PZ
- 4 shaping times
- Gain adjustable from 1 to 600 (optional 2000)
- Lemo-00 inputs.
- Low noise: 4 μVrms (gain = 100 and shaping time = 8 μs)
- Low integral non linearity
- Fully controllable via front panel
- Remote control via USB and mesytec control bus
- 4 selected timing filter integration times
- ECL timing delay can be switched off

Schematics:

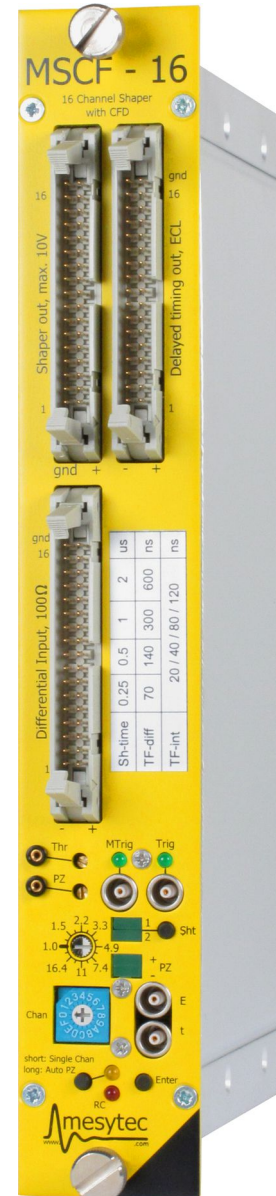
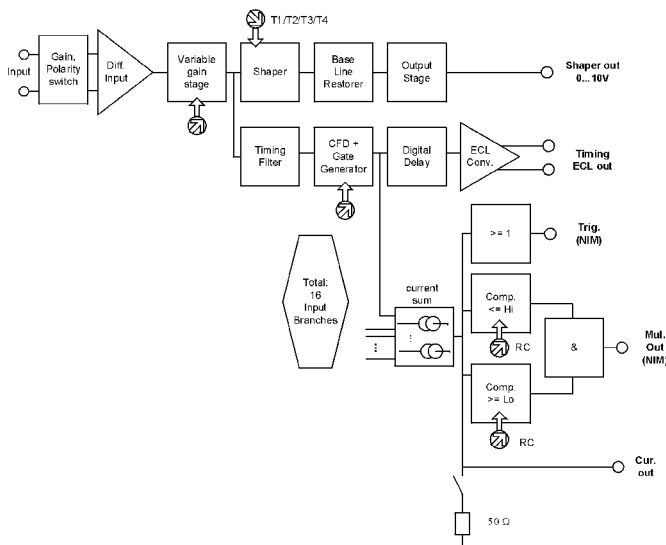

Technical Data

Input stage

- Polarity setting

Polarity of input signal can be set by jumper position. In the picture below, the lower jumper is set to the two positions.

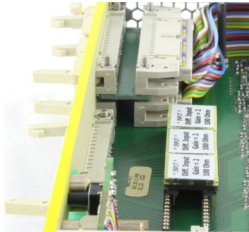

negative input signals

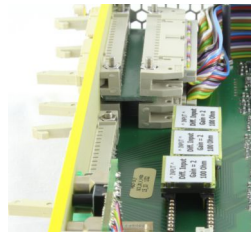

positive input signals

header connector, positive signal means: positive at + input and negative on – input.

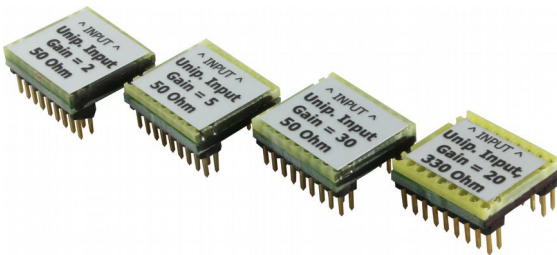

- Gain adjust: gain can be set from 1 to 20 in 16 steps with factor 1.22 per step. So with a gain jumper G20, a total gain of 20 to 400 is standard.
- Input connectors: 16x Lemo 00 series or 17x2 header connectors (differential input)
- Input termination: 330 Ω , 93 Ω or 50 Ω , coded on the gain-polarity jumper are possible. Gain factor from 1 to 60 are possible. See table for details.
- Input noise at gain = 50 and 8 μ s shaping time = 4.5 μ Vrms.

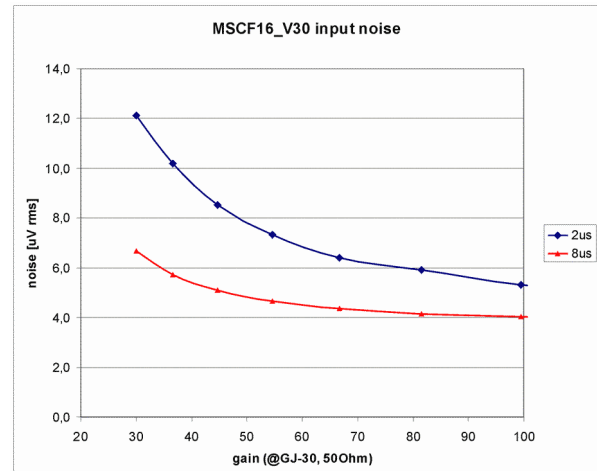

Input noise in μ Vrms with gain jumpers G30, 50 Ω input resistance. 4.5 μ Vrms shaper noise corresponds to 0.1 keV FWHM detector noise (at the typically 100 mV per MeV preamp sensitivity).

Shaper

- PZ adjustable with front panel trimmer. Range 15 μ s to ∞ .
- 5th order filter CR-RC⁵
- Four shaping times: (σ -values) 1 / 2 / 4 / 8 μ s selectable for groups of 4 channels
- Output amplitude: 0 to 10 V
- DC-Offset: VDC \pm 8 mV, common offset adjust.
- Output connector: 34 pin male connector
- Integral non linearity < TBD %
- gain drift < TBD % / $^{\circ}$ C
- Offset drift < 50 μ V / $^{\circ}$ C

Active baseline restorer

The active baseline restorers reduce the baseline shift by a factor of 1000. When pole zero is properly adjusted, the residual baseline shift will only give a very small contribution to the resolution.

Timing filter amplifier

Time constants: see Table

2 monitor outputs

For timing filter and amplitude signals, selectable by rotary switch. There might be some additional noise at the monitor output.

Discriminator

- CFD or Leading edge (jumper selectable)
- For CFD-200: delays selectable for groups of 4 channels: 30, 60, 130, 200 ns
- 2 fractions: selectable for groups of 4 channels: 20 % / 40 %
- CFD -Walk: for 30 ns (10 % to 90 %) input rise time, max 1 ns (dynamic range 100:1)
- Threshold: adjustable, 0 % to 30 % of maximum range, in 256 steps

Fraction and delay selection of the 4 channel CFD plug on modules

Fraction (sw1)

On: 20 %
Off: 40 %

Delay (sw1, sw2)

off off: 30 ns
on off: 60 ns
off on: 130 ns
on on: 200 ns

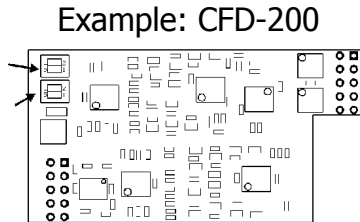

*For other CFD delays see section
"Types and ordering"*

See also label inside the movable module side plate.

Multiplicity trigger

- Each channel above threshold contributes to multiplicity level, a multiplicity trigger is generated for: lower multiplicity threshold \leq multiplicity level \leq upper multiplicity threshold
- Coincidence interval adjustable via RC from 20 ns up to 200 ns (default 75 ns).
- The multiplicity trigger is delayed by the coincidence time to the trigger signal.
- Multiplicities selectable via remote control
- Lower multiplicity threshold: 1 ... 8, upper multiplicity threshold: 1 ... 8 and ∞
- Multiplicity chaining: multiplicity outputs from several modules can be connected, resulting in a total multiplicity level of all connected modules. Multiplicity trigger windows of the connected modules act independently on the total multiplicity.

Power consumption: (max 9 W)

- + 6 V 350 mA
- - 6 V -700 mA
- +12 V 200 mA

Gate generator, Timing delay, ECL output

- Pulse width for trigger output: 800 ns
- Timing stop- ECL-Signals: delay 800 ns from trigger, width 200 ns
- Output connector: 34 pin male connector

MSCF-16 Front panel Operation

Most MSCF-16 parameters can be set and controlled via front panel elements.

Two parameters can be adjusted for each channel individually:

- Threshold
- PZ compensation

Two parameters can be adjusted in groups of four channels (channel 1-4, 5-8, 9-12 and 13-16):

- Gain
- Shaping time

All parameters can as well be set up for all channels in common. Thus there are two different modes of front panel operation:

Common mode:

Threshold, PZ, Gain and Shaping time have a common setting for all channels

Single mode:

Threshold and PZ settings for each individual channel
Gain and Shaping time for each groups of four channels

Common parameters can be copied to individual parameters to easily get a basis for individual settings.

Mode select

Clicking the “single chan” knob switches between single and common operating mode. The orange LED associated with the “single chan” knob signals single channel mode when lighted.

Monitor / Active Channel

One out of 16 available channels is available at the energy and timing monitor outputs. This is also the channel to be modified in Single mode.

Shaping time

Shaping times are changed around by clicking the “Sht” knob, the shaping time value of the currently selected channel (group) is displayed by two LEDs. They indicate an index from 0 (“1” and “2” LEDs both off) up to 3 (both LEDs on). Please refer to individual device labeling for corresponding shaping times.

Gain

Gain values are set by the gain dial, gain values are indicated on the front panel. Gain ranges from 1.0 to 20.0. It can be set commonly for all channels or individual for groups of four channels.

Threshold

Threshold is adjusted with a front panel trimmer, the corresponding voltage can be drawn from the test output. It can be set commonly for all channels or individually for each channel.

PZ

PZ compensation is also adjusted with a front panel trimmer, the corresponding voltage level is output on the test connector. It can be set commonly for all channels or individually for each channel.

General setup

Common mode

In common mode, the trimmer settings for threshold and PZ are followed immediately. Shaping time can be selected for all channels clicking the Sht knob. Gain is set for all channels by selecting the desired gain switch position.

Individual mode

In single channel mode, trimmer changes are only read and activated when the “enter” knob is pressed during changes. Threshold and PZ settings are remembered individually for each channel. Shaping times and gains are valid for a group of four channels.

Copying from Common to Individual

For an easy basic setup, common settings can be copied to the individual section. Fine tuning can then be done based on this basic setup. Copy is done by clicking the “Single chan” knob while “enter” is pressed.

Auto PZ setup

The PZ compensation values can be set up automatically – provided there’s a signal at the respective channels. Holding the “Single chan” knob for about two seconds starts the automatic pz setup. The values found are saved in the individual parameter set. Clicking “Single chan” again during autopz stops the process.

Remote Controlled Operation

MSCF-16 can be remotely controlled in two ways: USB control and event bus control.

MSCF-16 has two complete parameter sets, one for front panel operation, one for remote control. Switching RC on and off switches between these two parameter sets.

In RC mode there are several more parameters, which will also be used (but can not be controlled) in front panel mode:

- BLR on/off
- Coincidence time window
- Shaper offset
- Threshold offset
- BLR threshold
- Multiplicity trigger thresholds

USB Control

For USB control a USB 1.1 or 2.0 connection is required. The MSCF-16 can be operated as a generic serial device on a virtual com port.

Virtual Com Port (VCP) drivers for various operating systems for this rc mode can be derived from the manufacturer of the USB interface chip: www.ftdichip.com/Drivers/VCP.htm

The MSCF-16 can then be controlled e.g. using a terminal program or a proprietary control software.

Interface settings

By default, communication is set to:

9.6 kBd, Data format 8N1

Higher baud rates can be set using the “SB” cmd.

On power-up 9.6 kBd will be restored.

Device Parameters

Like in front panel mode thresholds and pz values can be adjusted in common or individually for each channel, while shaping times and gains can be set up for groups of four channels or in common. For common settings, there’s one virtual channel/group added to parameter indices:

Thresholds, pz compensation:

Channels 1 ... 16, 17 = common

Gain, shaping time:

Groups 1 ... 4, 5 = common

Command list

(each cmd terminated by <CR>)

DS	Display Setup (lists all gains, thresholds, pz values, shaping times, ...)
SB <i>n</i>	Set Baud rate to: n = 1: 9.600 Bd. (Power-Up default) 2: 19.200 Bd. 3: 28.400 Bd. 4: 57.600 Bd. 5: 115.200 Bd.
SG <i>group val</i>	Set Gain for groups of 4 channels group = 1...5 (5 = common mode) val = 0...15
SBL <i>val</i>	Switch BLR on/off (1/0)
SC <i>val</i>	Set coinc time window (0..255)
SBT <i>val</i>	Set BLR threshold (0..255)
ST <i>chan val</i>	Set threshold value chan = 1...17 (17 = common mode) val = 0...255
SP <i>chan val</i>	Set pz value chan = 1...17 (17 = common mode) val = 0...255
SS <i>group val</i>	Set shaping time for a group group = 1...5 (5 = common mode) val = 0...3
SM <i>hi lo</i>	Set multiplicity borders hi, lo = 1 ... 8
MC <i>chan</i>	Set monitor output to chan chan = 1...16
SI <i>0/1</i>	Single channel mode 0 = off, 1 = on
ON	Switch RC mode on
OFF	Switch RC mode off
AP	Switch automatic pz setting on/off
AP <i>chan</i>	automatic pz setting for chan 1..16
PZR range	Set display range for PZ display range = 1...255
CPY F	Copy front panel settings to RC memory
CPY R	Copy RC settings to front panel memory
V	Display firmware version

Settings via USB remote control will be saved in permanent memory and will be restored after next power up.

RC bus control

MSCF-16 can also be controlled using the MRC-1 / MRCC master controller modules.

Bus setup

Up to 32 devices (not only MSCF-16) – 16 on each of the two control buses – can be remotely controlled at a time.

Devices have to be connected with lemo cables and t-pieces, the last module on a bus has to be terminated with 50 Ω. The RC master is self terminated. Be sure to assign individual device addresses using the address coders!

RC commands

Remote control via RC bus is basically performed by reading and writing the control register page of the MSCF-16. Basic commands are:

Read: *RE b a m*

Write (Set): *SE b a m v*

With:

b = bus number (0/1)

a = device address (0 ... 15)

m = memory address

v = value

Memory List MSCF-16

The following table shows the MSCF-16 memory layout:

ADR	parameter	comment
0	Gain group 1	Gain setting for channel 1 ... 3 and common mode Values from 0 ... 15
1	Gain group 2	
2	Gain group 3	
3	Gain group 4	
4	Gain common	
5	Threshold channel 1	Threshold values for channel 1 ... 16, 17 = common Values from 0 ... 255
6	Threshold channel 2	
7	Threshold channel 3	
8	Threshold channel 4	
9	Threshold channel 5	
10	Threshold channel 6	
11	Threshold channel 7	
12	Threshold channel 8	
13	Threshold channel 9	
14	Threshold channel 10	
15	Threshold channel 11	
16	Threshold channel 12	
17	Threshold channel 13	

18	Threshold channel 14	PZ values for channel 1 ... 16, 17 = common Values from 0 ... 255
19	Threshold channel 15	
20	Threshold channel 16	
21	Threshold common	
22	PZ value channel 1	
23	PZ value channel 2	
24	PZ value channel 3	
25	PZ value channel 4	
26	PZ value channel 5	
27	PZ value channel 6	
28	PZ value channel 7	
29	PZ value channel 8	
30	PZ value channel 9	
31	PZ value channel 10	
32	PZ value channel 11	
33	PZ value channel 12	
34	PZ value channel 13	
35	PZ value channel 14	
36	PZ value channel 15	
37	PZ value channel 16	
38	PZ value common	
39	Shaping time group 1	Shaping time settings for group 1 ... 3 and common mode Values from 0 ... 3
40	Shaping time group 2	
41	Shaping time group 3	
42	Shaping time group 4	
43	Shaping time common	
44	Multiplicity hi	Multiplicity values 1 ... 8
45	Multiplicity lo	
46	Monitor channel	1 ... 16
47	Single channel mode	1 = on, 0 = off
48	RC	1 = on, 0 = off (set automatically by ON / OFF cmd via MRC-1 / MRCC)
49	Version information	16 * maj + min.
50	BLR threshold	0 ... 255
51	BLR on/off	1 = on, 0 = off
52	Coinc. Time	0 ... 255
53	Threshold offset	100 (=no offs) ±100
54	Shaper offset	100 (=no offs) ±100
55	Sumdis Threshold	(only special models)
56	PZ display range	1 ... 255
99	Copy Function (write only)	1: copy panel → RC 2: copy RC → panel 3: copy RC common → single
100	Start/Stop auto PZ	Write: 0: stop 1...16: single channel auto PZ 17: all channels auto PZ Read: currently processed channel

Parameters can be read / written while RC on or off, but will take effect only when RC is on.

While RC ON, the front panel control will be blocked until "Enter" is pressed.

When shut down during RC on, the RC values will be restored after next power up and rc will be active again.

Identification code for MSCF-16 (detected when running the scan bus command "SC") is IDC = 21.

MSCF-16 PCB overview

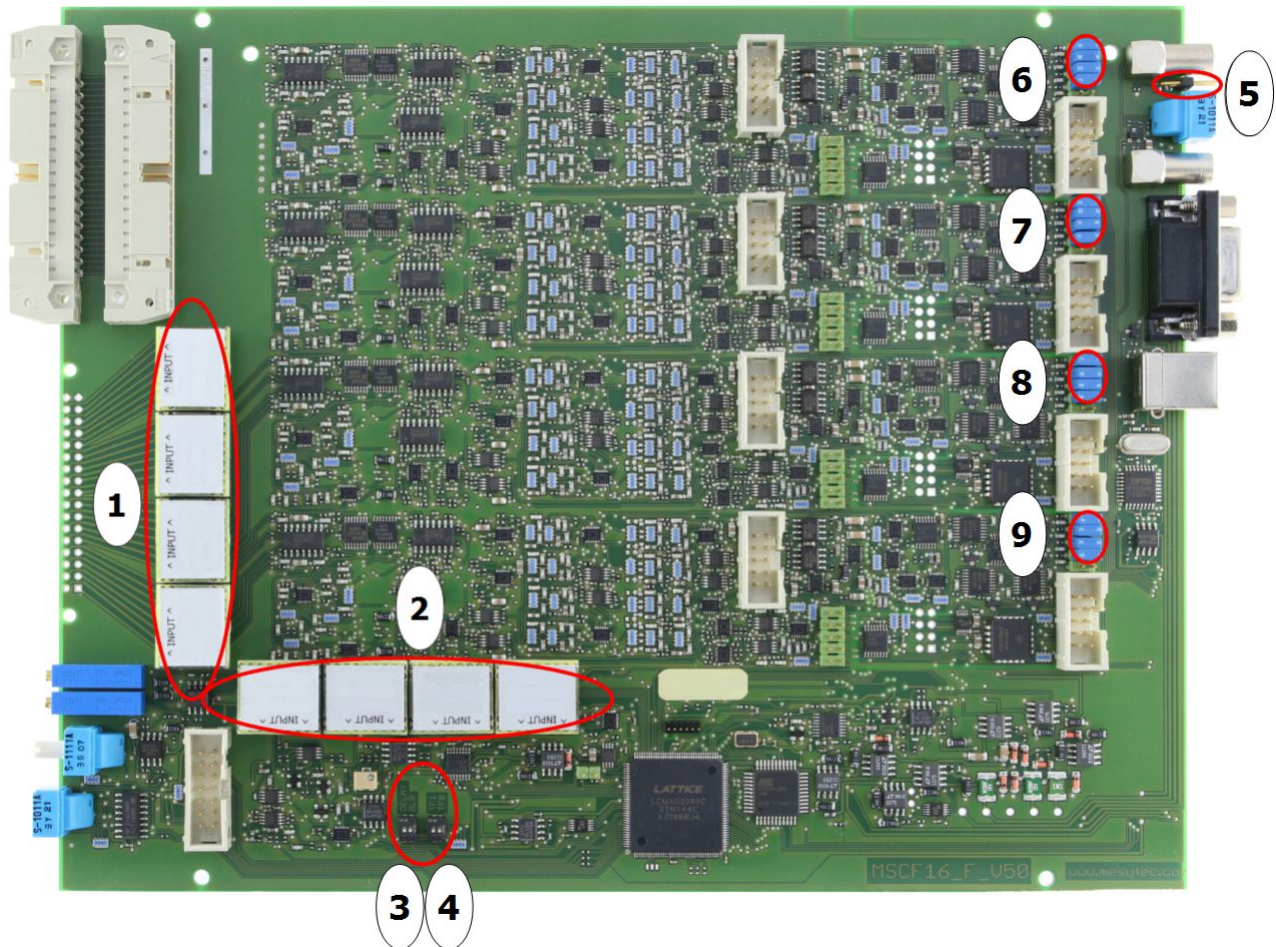

- 1: Position for the active gain-polarity jumpers.
- 2: Position to store up to 4 spare jumpers
- 3: BLR on/off, ECL Trigger delay on/off
- 4: Timing filter integration time
- 5: 50 Ω jumper. Is needed if modules are not connected for common multiplicity.
- 6 to 9 : Connector usually occupied by CFD modules. To use only leading edge discriminators, remove CFD module and insert 16 jumpers at the upper positions, 4 for each connector. The lower pair on each connector is ground and can be left free.

Types and ordering

Example MSCF-16 for Ge detector readout

Module name	Shaping times (sigma)	Input type	Input connector	Discriminator	CFD-Delay
MSCF-16_LN	_SH8 1 us, 2 us, 4 us, 8 us TF-dif: 330 ns, 550 ns, 750 ns 1.0 us	_V Voltage for current preamp signals	_L Lemo	_CFD Constant fraction discriminator LE Or leading edge only	200 -

Connected parameters

The timing filter differentiation time corresponds to the selected shaping time. So shortest shaping time results in shortest TF differentiation time.

CFD plug in modules (4 modules per MSCF-16 needed)

CFD-Name	Fraction (via dipswitch)	Delays (via dipswitch)
CFD-60	20 % / 40 %	10, 20, 40, 60 ns
CFD-120	20 % / 40 %	20, 40, 80, 120 ns
CFD-200	20 % / 40 %	30, 60, 130, 200 ns

Existing types

Alias	Module name	comment
Ge-Type	MSCF-16_LN_SH8_V_L_CFD200 / LE	Gain jumpers: G5-50 R, G30-50 R For high performance spectroscopy with Ge-detector ECL output delay switchable 0us / 0.8 us TF differentiation time of 330 ns, 550 ns, 750 ns, 1.0 us TF integration time: 40 ns, 80 ns, 150 ns, 200 ns BLR threshold step: 1 mV (max 255 mV)

Variations of output configuration and CFD / LE configuration are available without extra costs.